

Plan View

10'

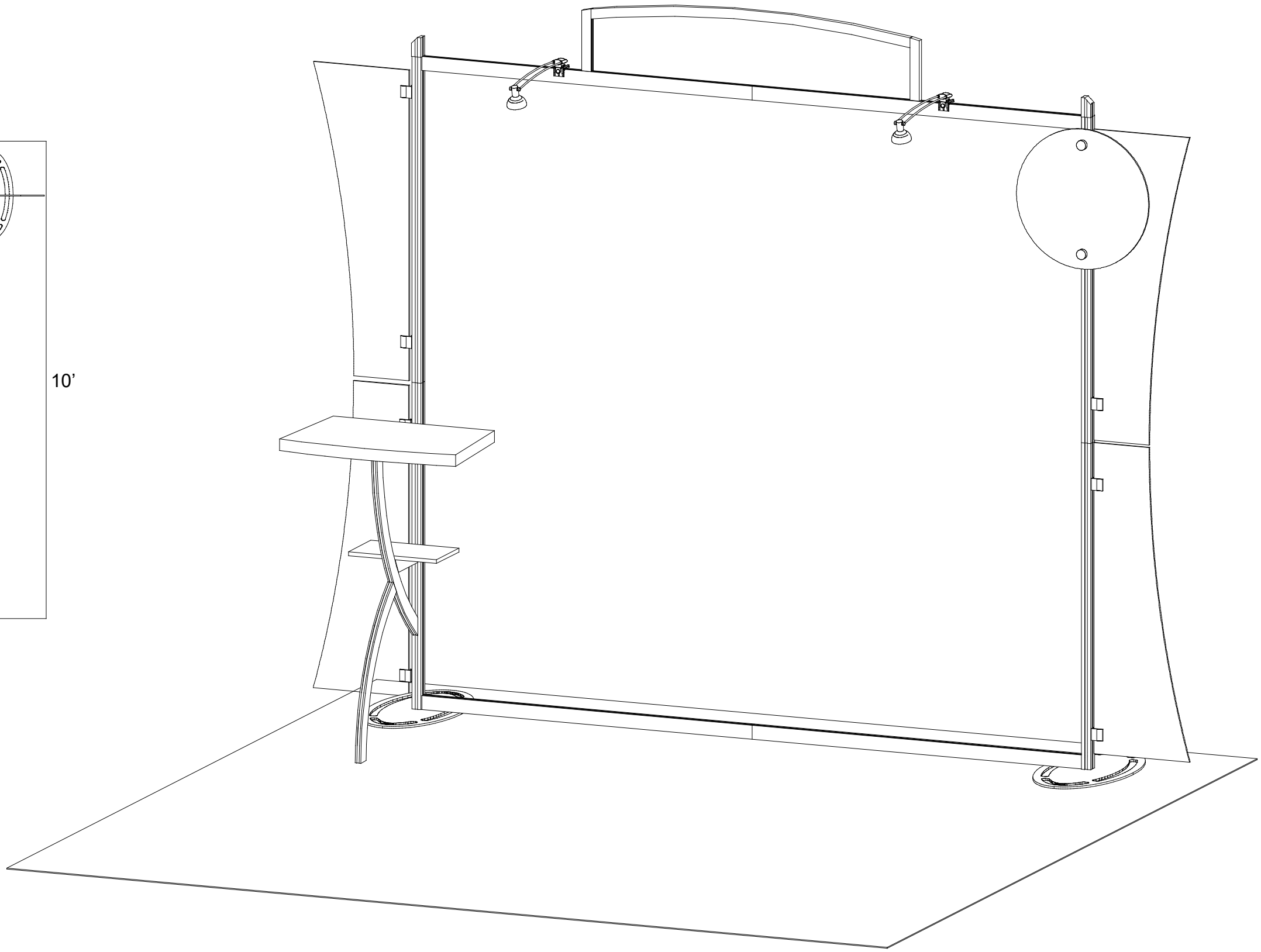

 **SETUP INSTRUCTIONS**

If you would like to tell us about your experience with your setup instructions please email us at [info@classicexhibits.com](mailto:info@classicexhibits.com)

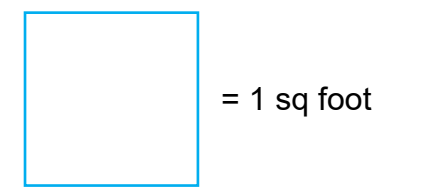
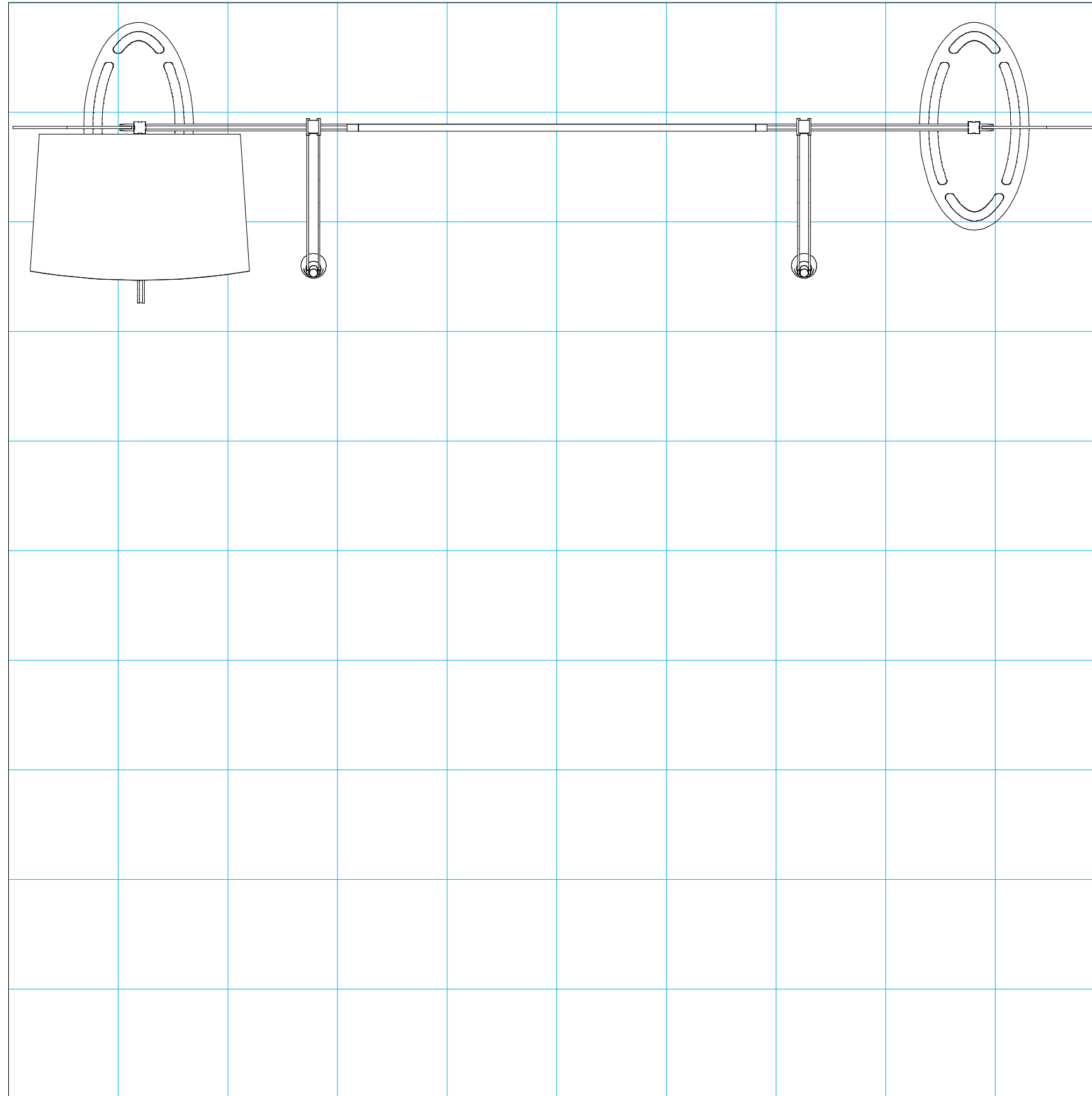

## General Setup Instructions

- Read entire setup instruction manual prior to unpacking parts and pieces.
- The setup instructions are created specifically for this configuration.
- Setup instructions are laid out sequentially in steps, including exploded views with detailed explanation for assembly.

## Cleaning & Packing

- For Cleaning Metal, Plex, & Laminate Parts: Use a **MILD NON-ABRASIVE** cleanser and soft cloth/paper towel to clean all surfaces.
- Keep exhibit components away from heat and prolonged sun exposure. **Heat and UV exposure will warp and fade components.**
- Retain all provided Packing Materials. All provided packing materials are for ease of repacking & component protection.

## Disassembly

- For loss prevention, tighten all set screws and locks during disassembly.

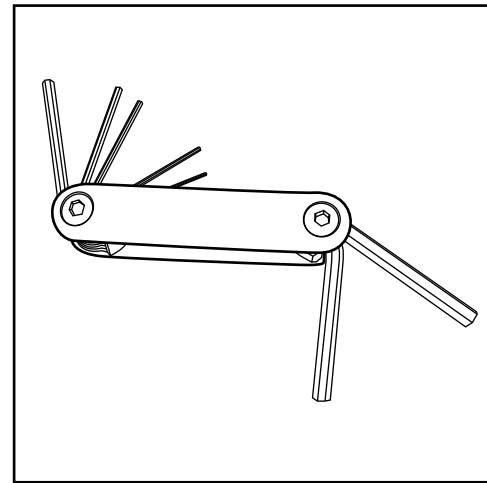

Hex Tool - Essential for Assembly

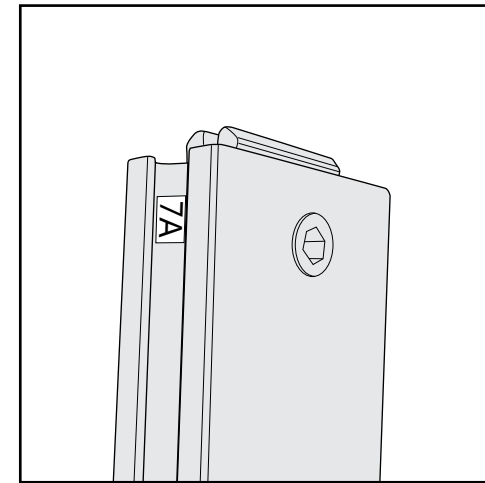

Part Identification - Numbering



Spline Connection



Base Plate & Extrusion Connection



Extrusion & Lock Connection



Engaged Lock



**WARNING**

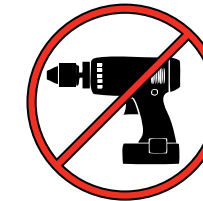

DO NOT USE POWER TOOLS

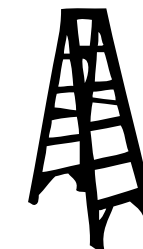

LADDERS OR LIFTS  
MAY BE REQUIRED



ALL CONNECTIONS MUST  
BE TIGHTLY SECURED



1) Mounting plate & wing nuts, in packed position.

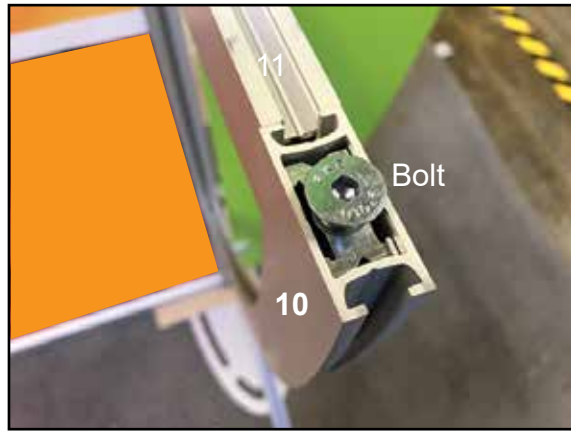

2) Mounting plate bolt in, packed position.

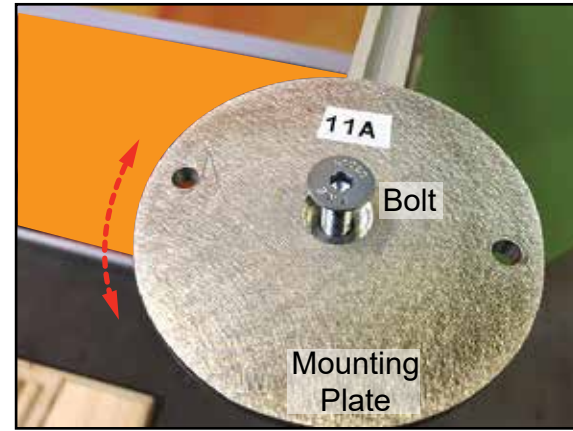

3) Place mounting plate onto [10] then tighten bolt, part way, allowing some rotation for final positioning.

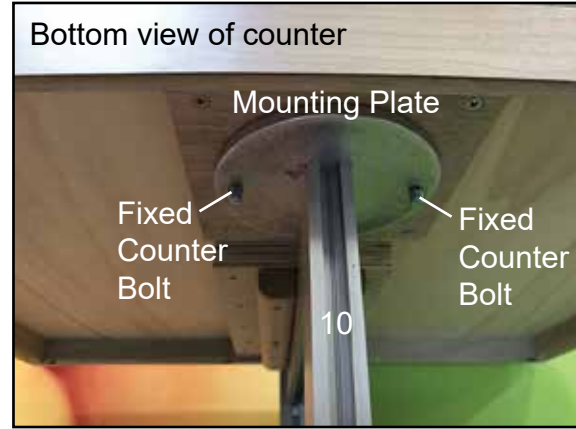
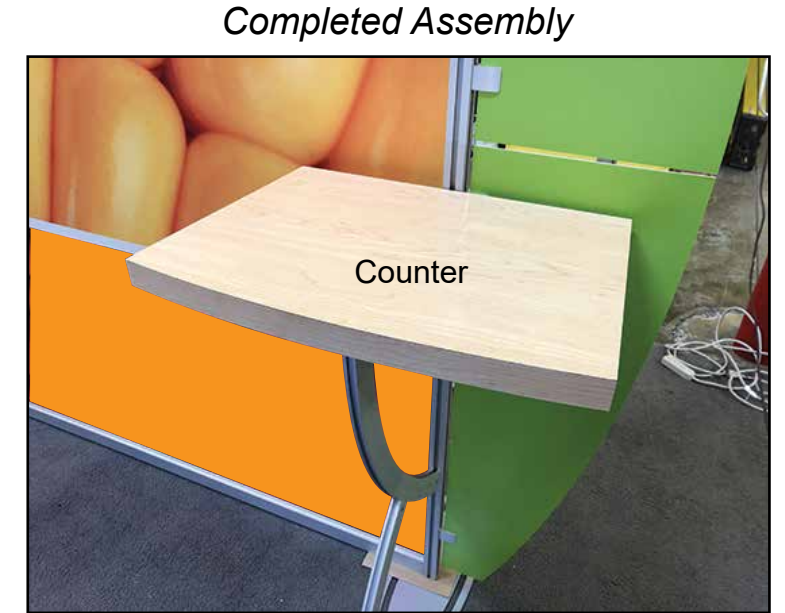

4) Place fixed counter bolts into mounting plate, then lift counter to re-tighten bolt.

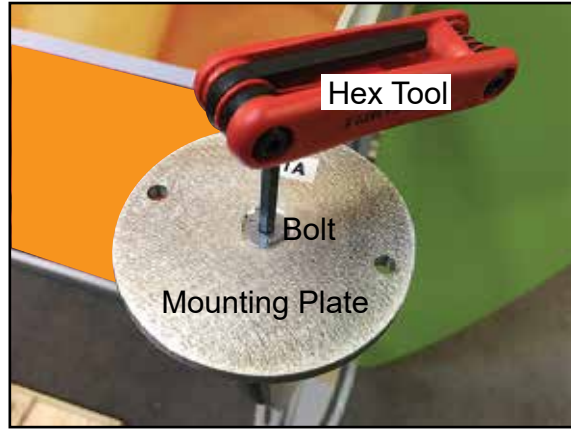

5) Tighten bolt, using hex tool, to secure.

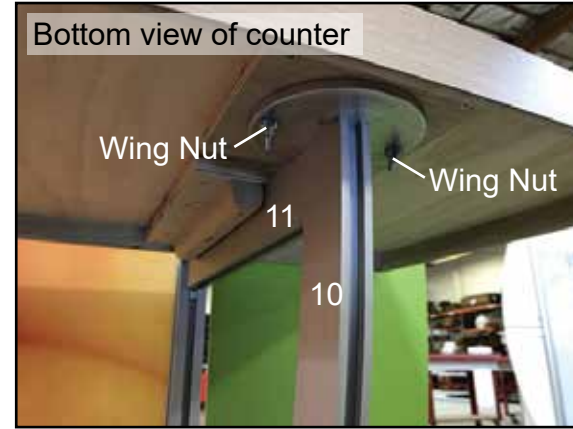

6) Place fixed counter bolts into mounting plate, then secure using wing nuts.

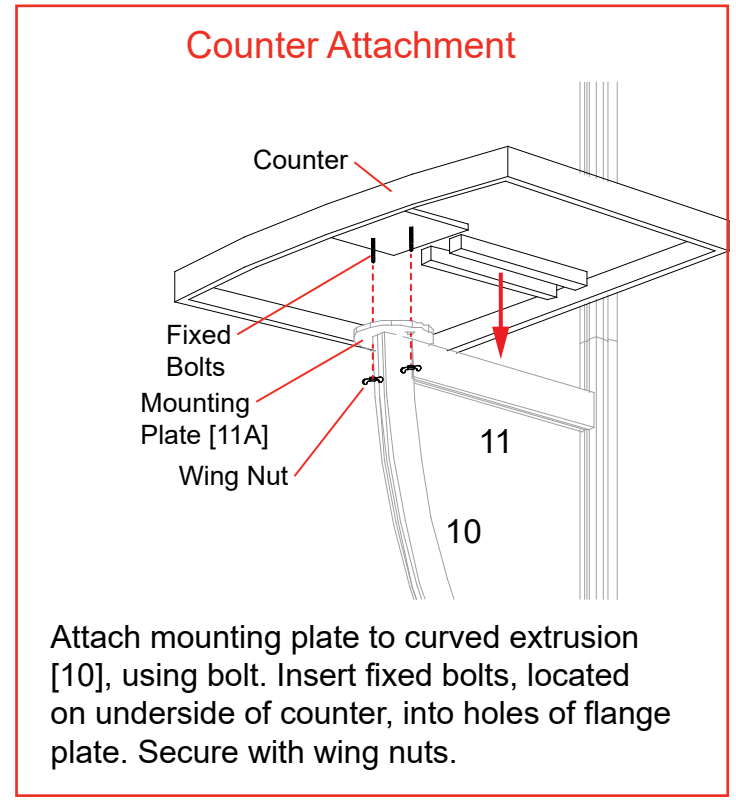

Keep mounting plate [11A] and wing nuts attached to counter, when packing.

Keep bolt attached to [10], when packing.

### Top View of Each Level

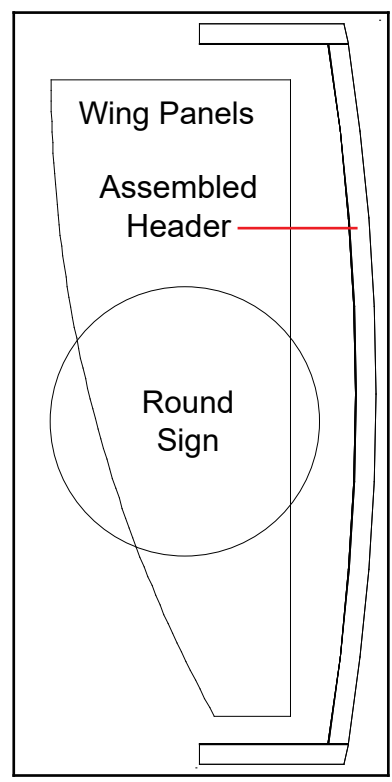

Level 1 (Bottom Level)

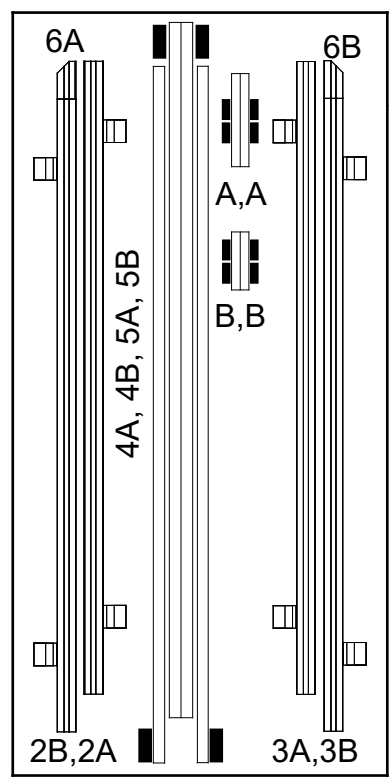

Level 2

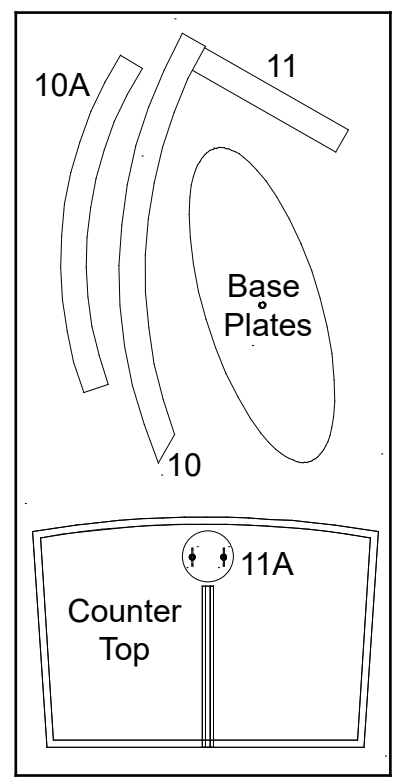

Level 3

Lights

Graphics

Setup Hardware

Shelf



Item	Qty.	Description
1	2	Base Plate
2A,2B	1,1	42" S40 Vertical Extrusion w/ A10 Clamps
3A,3B	1,1	42" S40 Vertical Extrusion w/ A10 Clamps
4A,4B	1,1	45" Z45 Horizontal Extrusion
5A,5B	1,1	45" Z45 Horizontal Extrusion
6A,6B	1,1	2.5" S40 Angle-Cut Vertical

Steps:

- 1) Attach base plates [1] lower verticals [2A] and [3A], using bolts.
- 2) Connect verticals [2A to 2B] and [3A to 3B], using connection bars [B].  
See [Straight Connection with Knobs](#) detail.
- 3) Connect horizontals [4A to 4B] and [5A to 5B], using connection bars [A].  
See [Straight Connection with Knobs](#) detail.
- 4) Connect assemblies [2A/2B] and [3A/3B] with assemblies [4A/4B] and [5A/5B].  
See [Corner Connection with Knob](#) detail.
- 5) Connect extrusions [6A to 2B] and [6B to 3B].  
See [2.5" h Angle-Cut Vertical Attachment](#) detail.
- 6) Attach graphic to Velcro on back of assembled Backwall.

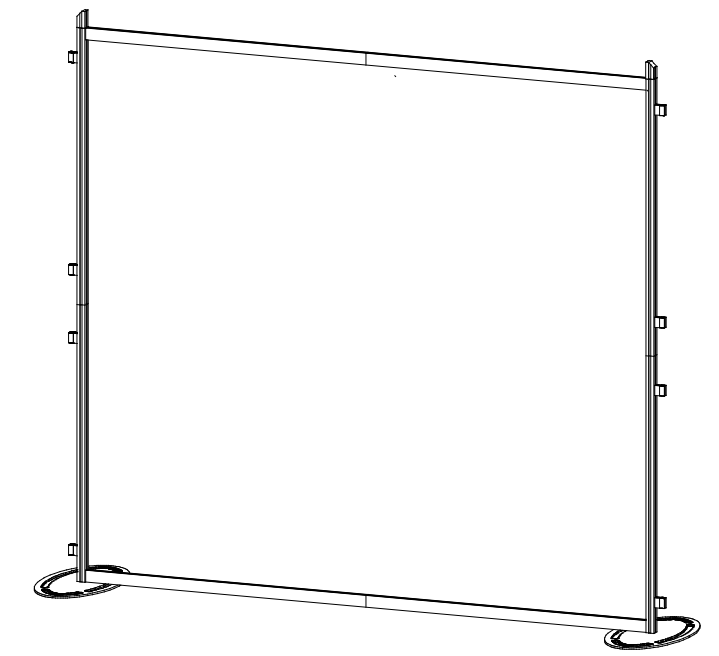

When Assembled

Keep extrusions [6A,6B] attached to [2B,3B].  
Keep A10 clamps attached to [2A,2B,3A,3B].

★ **Corner Connection with Knob**



Turn knob clockwise to tighten lock.

Do not over tighten Knobs

◆ **Straight Connection with Knobs**

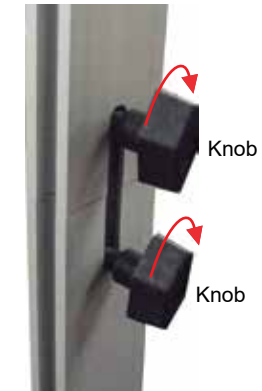

Slide connection bar between extrusions, then turn knobs clockwise to tighten lock.

Do not over tighten Knobs

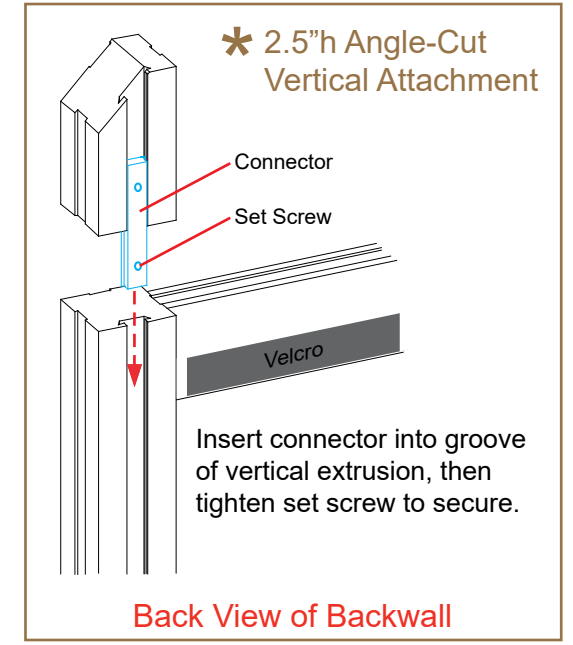
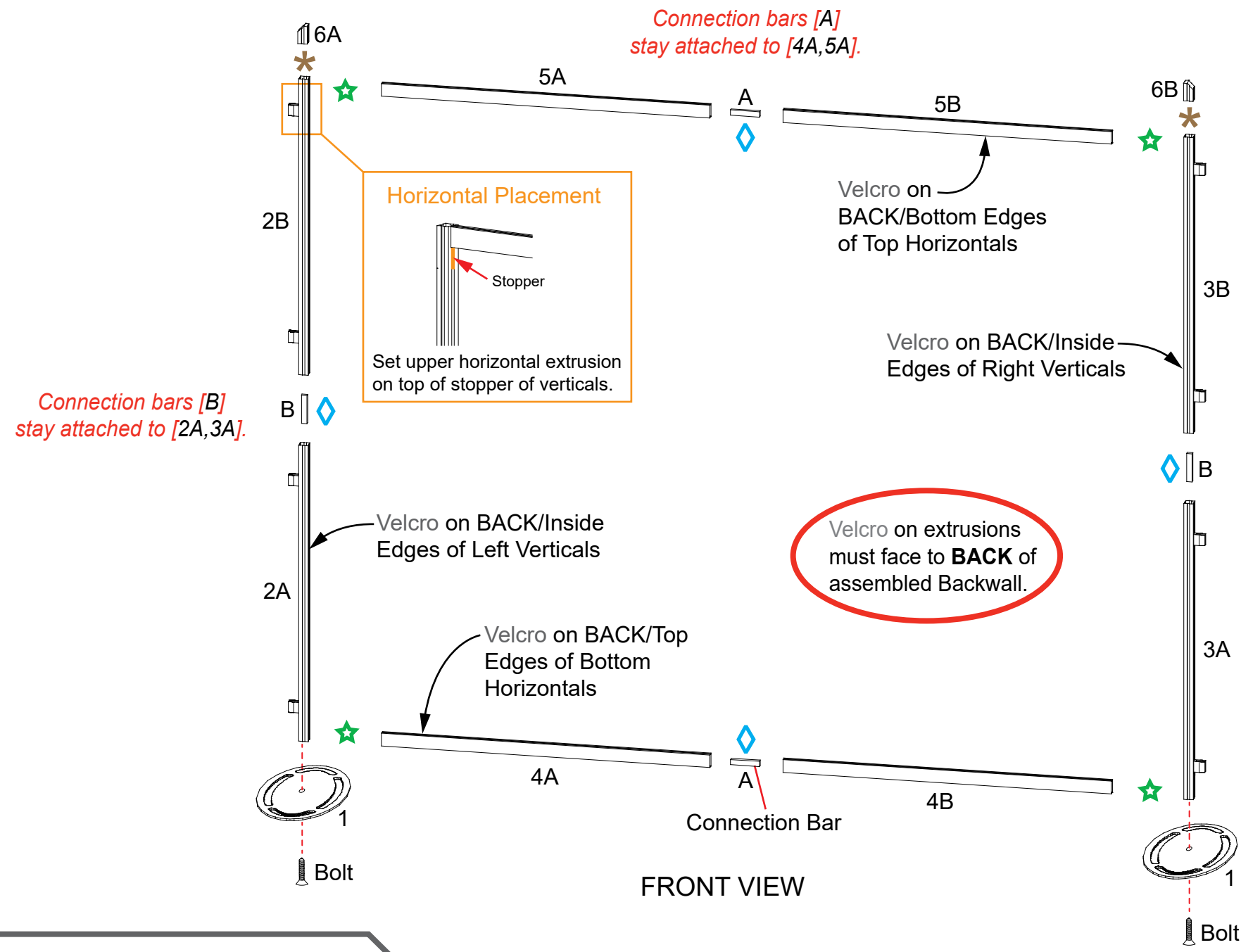

Steps:

- 1) Connect lights to top horizontal extrusions [5A/5B]. See [Light Connection](#) detail.
- 2) Attach assembled Header Frame and affix graphic using Velcro.
- 3) Attach extrusions [10/11] and shelf to vertical [2A].
- 4) Attach support leg [10A] to curved extrusion [10].
- 5) Attach flange plate [11A] to top of curved extrusion [10], using bolt.
- 6) Attach counter top to counter mounting plate [11A]. See Counter Assembly page.
- 7) Attach Wings to A10 clamps. See [Clamp Attachment](#) detail.
- 8) Attach Sign to vertical extrusion [3B]. See [Sign Attachment](#) detail.

Item	Qty.	Description
7/8/9	1/1/1	Header Frame
10	1	30.2" Curved Extrusion
10A	1	Support Leg
11	1	12.184" Horizontal Extrusion
11A	1	Counter Mounting Plate

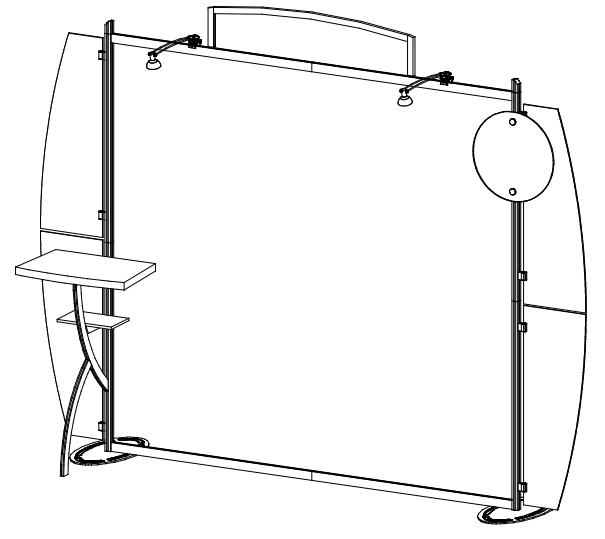

When assembled

**Clamp Attachment**

- 1) Slide connector of clamp into extrusion groove.
- 2) Tighten set screw when A10 is in desired location.
- 3) Insert wing into clamp.
- 4) Tighten knob on clamp to secure wing in place.

Keep A10 clamps attached to verticals.

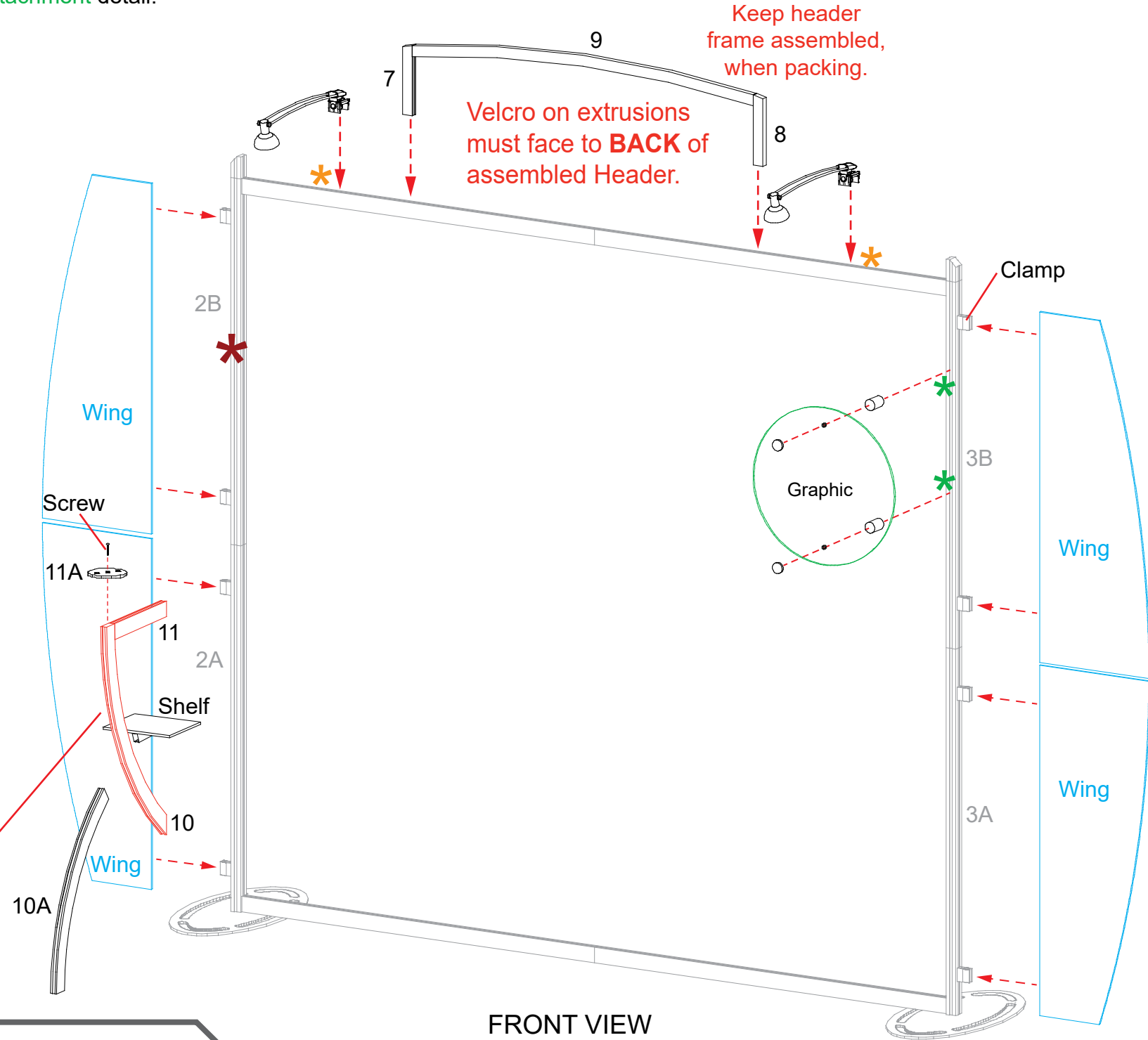

**\* Light Connection**

Slide light onto clip then lock clip into groove of horizontal extrusion.

**\* Sign Attachment**

Slide connector into groove of extrusion. Tighten set screws to secure in place. Screw standoff into connector. Place sign between standoff and cap then tighten cap to secure sign.